

**Part Number: PT347-07140**

**Kit Contents**

| Item # | Quantity Req. | Description     |
|--------|---------------|-----------------|
| 1      | 1             | Convenience Net |
|        |               |                 |
|        |               |                 |

**Hardware Bag Contents**

| Item # | Quantity Req. | Description |
|--------|---------------|-------------|
|        |               |             |
|        |               |             |

**Additional Items Required For Installation**

| Item # | Quantity Req. | Description |
|--------|---------------|-------------|
|        |               |             |
|        |               |             |

**Conflicts**

|      |
|------|
| None |
|------|

**Recommended Tools**

|  |              |
|--|--------------|
| <b>Personal &amp; Vehicle Protection</b> | <b>Notes</b> |
| None                                     |              |
| <b>Special Tools</b>                     | <b>Notes</b> |
| None                                     |              |
| <b>Installation Tools</b>                | <b>Notes</b> |
| None                                     |              |
| <b>Special Chemicals</b>                 | <b>Notes</b> |
| None                                     |              |

**General Applicability**

|     |
|-----|
| All |
|-----|

**Recommended Sequence of Application**







| Item # | Accessory |
|--------|-----------|
|        |           |
|        |           |
|        |           |

\*Mandatory

**Vehicle Service Parts** (may be required for reassembly)

| Item # | Quantity Req. | Description |
|--------|---------------|-------------|
|        |               |             |
|        |               |             |
|        |               |             |

**Legend**

|  |  |
|--|--|
|   | <b>STOP:</b> Damage to the vehicle may occur. Do not proceed until process has been complied with.   |
|   | <b>OPERATOR SAFETY:</b> Use caution to avoid risk of injury.   |
|   | <b>CAUTION:</b> A process that must be carefully observed in order to reduce the risk of damage to the accessory/vehicle and to ensure a quality installation. |
|   | <b>TOOLS &amp; EQUIPMENT:</b> Used in Figures calls out the specific tools and equipment recommended for this process.   |
|   | <b>REVISION MARK:</b> This mark highlights a change in installation with respect to previous issue.  |
|  | <b>SAFETY TORQUE:</b> This mark indicates that torque is related to safety.  |

Care must be taken when installing this accessory to ensure damage does not occur to the vehicle. The installation of this accessory should follow approved guidelines to ensure a quality installation.

These guidelines can be found in the "Accessory Installation Practices" document.

This document covers such items as:-

- Vehicle Protection (use of covers and blankets, cleaning chemicals, etc.).
- Safety (eye protection, rechecking torque procedure, etc.).
- Vehicle Disassembly/Reassembly (panel removal, part storage, etc.).
- Electrical Component Disassembly/Reassembly (battery disconnection, connector removal, etc.).

Please see your Toyota dealer for a copy of this document.

### 1. Installation of Cargo Net.

- (a) Open the trunk and locate the anchor locations on the passenger's side of the vehicle (Fig 1-1).

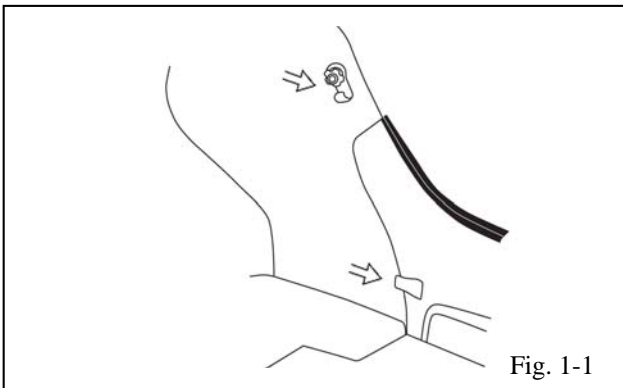

-  (b) With the net handle facing out toward the rear of the vehicle, attach the loop at the top of the net to the vehicle anchor as shown (Fig. 1-2).

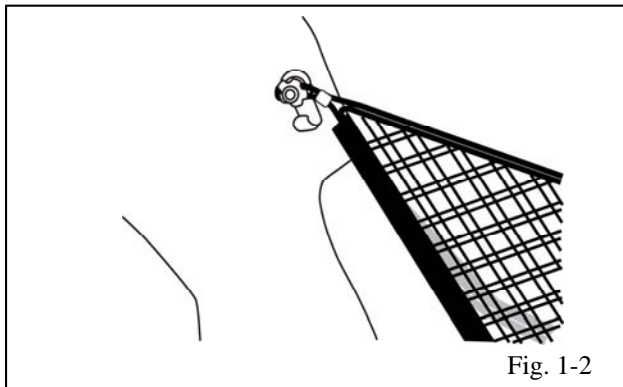

- (c) Attach the loop at the bottom of the net to the vehicle as shown (Fig. 1-3).

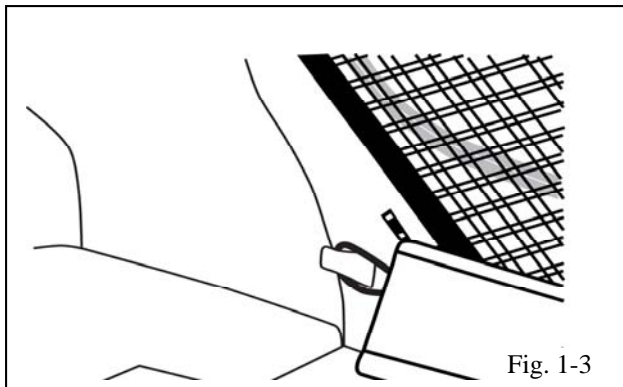

- (d) Repeat steps 1(a) through 1(c) for the opposite side of the vehicle.

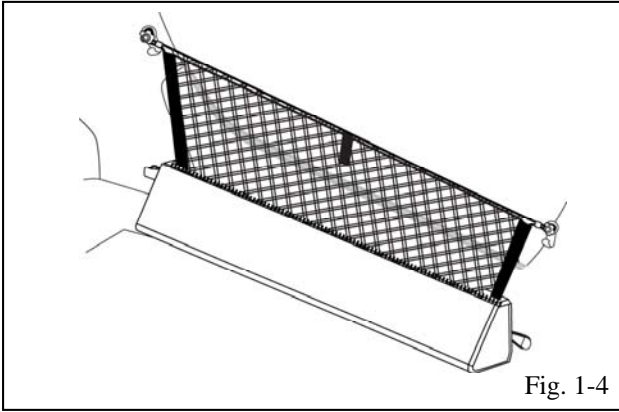

-  (e) Confirm the completed assembly. Make sure the net handle is facing out toward the rear of the vehicle (Fig. 1-4).

| <u>Check:</u>  | <u>Look For:</u>   |
|--|--|
| <p><u>Accessory Function Checks</u></p> <p><input type="checkbox"/> Confirm that the net is attached properly to the anchor points in the vehicle.</p>               | <p>Make sure the loops are attached to the vehicle anchors at the top and bottom. The net handle should face out toward the rear of the vehicle.</p>                           |
| <p><u>Vehicle Function Checks</u></p> <p><input type="checkbox"/> Vehicle door operation</p>   | <p>Confirm vehicle door opens and closes without interference from Cargo Net.</p>  |
| <p><u>Vehicle Appearance Check</u></p> <p><input type="checkbox"/> After accessory installation and removal of protective cover(s), perform a visual inspection.</p> | <p>Ensure no damage (including scuffs and scratches) was caused during the installation process (For PPO installations, refer to TMS Accessory Quality Shipping Standard).</p> |